

# Deutsches Institut für Bautechnik

Anstalt des öffentlichen Rechts

Kolonnenstr. 30 L  
10829 Berlin  
Germany

Tel.: +49(0)30 787 30 0  
Fax: +49(0)30 787 30 320  
E-mail: [dibt@dibt.de](mailto:dibt@dibt.de)  
Internet: [www.dibt.de](http://www.dibt.de)

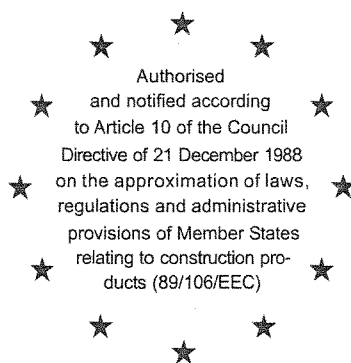

# DIBt

Mitglied der EOTA  
*Member of EOTA*

## European Technical Approval ETA-05/0133

English translation prepared by DIBt - Original version in German language

**Handelsbezeichnung**  
*Trade name*

**Pattex CF 900 mit Ankerstange 5.8**  
*Pattex CF 900 with anchor rod 5.8*

**Zulassungsinhaber**  
*Holder of approval*

**Henkel KGaA**  
Henkelstraße 67  
40191 Düsseldorf

**Zulassungsgegenstand  
und Verwendungszweck**

**Verbunddübel (Injektionssystem) mit Ankerstange aus  
galvanisch verzinktem Stahl in den Größen M10, M12 und  
M16 zur Verankerung im ungerissenen Beton**

*Generic type and use  
of construction product*

*Bonded anchor (injection type) with anchor rod made of galvanised  
steel of sizes M10, M12 and M16 for use in non-cracked concrete*

**Geltungsdauer:** vom  
*Validity:* from  
bis  
to

**19 May 2005**  
**25 February 2010**

**Herstellwerk**  
*Manufacturing plant*

**Henkel KGaA, Werk 2, Deutschland**

**Diese Zulassung umfasst**  
*This Approval contains*

**16 Seiten einschließlich 7 Anhänge**  
*16 pages including 7 annexes*



Europäische Organisation für Technische Zulassungen  
European Organisation for Technical Approvals

## I LEGAL BASES AND GENERAL CONDITIONS

- 1 This European Technical Approval is issued by the Deutsches Institut für Bautechnik in accordance with:
  - Council Directive 89/106/EEC of 21 December 1988 on the approximation of laws, regulations and administrative provisions of Member States relating to construction products<sup>1</sup>, modified by Council Directive 93/68/EEC<sup>2</sup> and Regulation (EC) N° 1882/2003 of the European Parliament and of the Council<sup>3</sup>;
  - Gesetz über das In-Verkehr-Bringen von und den freien Warenverkehr mit Bauprodukten zur Umsetzung der Richtlinie 89/106/EWG des Rates vom 21. Dezember 1988 zur Angleichung der Rechts- und Verwaltungsvorschriften der Mitgliedstaaten über Bauprodukte und anderer Rechtsakte der Europäischen Gemeinschaften (Bauproduktengesetz - BauPG) vom 28. April 1998<sup>4</sup>, zuletzt geändert durch Gesetz vom 06.01.2004<sup>5</sup>.
  - Common Procedural Rules for Requesting, Preparing and the Granting of European Technical Approvals set out in the Annex to Commission Decision 94/23/EC<sup>6</sup>;
  - Guideline for European Technical Approval of "Metal Anchors for Use in Concrete" ETAG 001, edition 1997, Part 1 "Anchors in general" and Part 5 "Bonded anchors".
- 2 The Deutsches Institut für Bautechnik is authorized to check whether the provisions of this European Technical Approval are met. Checking may take place in the manufacturing plant. Nevertheless, the responsibility for the conformity of the products to the European Technical Approval and for their fitness for the intended use remains with the holder of the European Technical Approval.
- 3 This European Technical Approval is not to be transferred to manufacturers or agents of manufacturers other than those indicated on page 1, or manufacturing plants other than those indicated on page 1 of this European Technical Approval.
- 4 This European Technical Approval may be withdrawn by the Deutsches Institut für Bautechnik, in particular pursuant to information by the Commission according to Article 5(1) of Council Directive 89/106/EEC.
- 5 Reproduction of this European Technical Approval including transmission by electronic means shall be in full. However, partial reproduction can be made with the written consent of the Deutsches Institut für Bautechnik. In this case partial reproduction has to be designated as such. Texts and drawings of advertising brochures shall not contradict or misuse the European Technical Approval.
- 6 The European Technical Approval is issued by the approval body in its official language. This version corresponds fully to the version circulated in EOTA. Translations into other languages have to be designated as such.

---

1 Official Journal of the European Communities N° L 40, 11.02.1989, p. 12  
2 Official Journal of the European Communities N° L 220, 30.08.1993, p. 1  
3 Official Journal of the European Union N° L 284, 31.10.2003, p. 1  
4 Bundesgesetzblatt I, p. 812  
5 Bundesgesetzblatt I, p.2, 15  
6 Official Journal of the European Communities N° L 17, 20.01.1994, p. 34

## **II SPECIFIC CONDITIONS OF THE EUROPEAN TECHNICAL APPROVAL**

### **1 Definition of product and intended use**

#### **1.1 Definition of product**

The Pattex CF 900 mit Ankerstange 5.8 is a bonded anchor (injection type) consisting of a mortar cartridge with Injection Mortar Pattex CF 900 and an anchor rod with hexagon nut and washer in the range of M10, M12 and M16. The anchor rod (including nut and washer) are made of galvanised steel. The anchor rod is placed into a drilled hole filled with injection mortar and is anchored via the bond between anchor rod, injection mortar and concrete.

An illustration of the product and intended use is given in Annex 1.

#### **1.2 Intended use**

The anchor is intended to be used for anchorages for which requirements for mechanical resistance and stability and safety in use in the sense of the Essential Requirements 1 and 4 of Council Directive 89/106 EEC shall be fulfilled and failure of anchorages made with these products would cause risk to human life and/or lead to considerable economic consequences. Safety in case of fire (Essential Requirement 2) is not covered in this ETA. The anchor is to be used only for anchorages subject to static or quasi-static loading in reinforced or unreinforced normal weight concrete of strength classes C20/25 at minimum and C50/60 at most according to EN 206:2000-12. It may be anchored in non-cracked concrete only.

The anchor may only be used in structures subject to dry internal conditions.

The anchor may be installed in dry or wet concrete, it must not be installed in flooded holes. Overhead installation is not admissible.

The anchor may be used in the following temperature ranges:

Temperature range: -40 °C to +80 °C (max short term temperature +80 °C and max long term temperature +50 °C)

Temperature range: -40 °C to +120 °C (max short term temperature +120 °C and max long term temperature +72 °C).

The provisions made in this European Technical Approval are based on an assumed intended working life of the anchor of 50 years. The indications given on the working life cannot be interpreted as a guarantee given by the producer, but are to be regarded only as a means for choosing the right products in relation to the expected economically reasonable working life of the works.

### **2 Characteristics of product and methods of verification**

#### **2.1 Characteristics of product**

The anchor corresponds to the drawings and provisions given in Annexes 2 to 4. The characteristic material values, dimensions and tolerances of the anchor not given in Annexes 2 to 4 shall correspond to the respective values laid down in the technical documentation<sup>7</sup> of this European Technical Approval.

The characteristic anchor values for the design of anchorages are given in Annexes 6 and 7.

<sup>7</sup> The technical documentation of this European Technical Approval is deposited at the Deutsches Institut für Bautechnik and, as far as relevant for the tasks of the approved bodies involved in the attestation of conformity procedure, is handed over to the approved bodies.

Each anchor rod shall be marked with the works symbol, the anchor identity and with the anchor size in accordance with Annex 2. Each mortar cartridge shall be marked with the identifying mark of the producer and with the trade name.

The two components of the Injection Mortar Pattex CF 900 are delivered in unmixed condition in mortar cartridges of 150 ml, 280 ml, 300 ml, 330 ml, 380 ml or 410 ml (coaxial type) or 345 ml (side-by-side type) according to Annex 4.

## **2.2 Methods of verification**

The assessment of fitness of the anchor for the intended use in relation to the requirements for mechanical resistance and stability and safety in use in the sense of the Essential Requirements 1 and 4 has been made in accordance with the "Guideline for European Technical Approval of Metal Anchors for Use in Concrete", Part 1 "Anchors in general" and Part 5 "Bonded anchors", on the basis of Option 7.

In addition to the specific clauses relating to dangerous substances contained in this European Technical Approval, there may be other requirements applicable to the products falling within its scope (e.g. transposed European legislation and national laws, regulations and administrative provisions). In order to meet the provisions of the EU Construction Products Directive, these requirements need also to be complied with, when and where they apply.

## **3 Evaluation of Conformity and CE marking**

### **3.1 Attestation of Conformity system**

The system of attestation of conformity 2(i) (referred to as System 1) according to Council Directive 89/106/EEC Annex III laid down by the European Commission provides:

a) tasks for the manufacturer:

- (1) factory production control;
- (2) further testing of samples taken at the factory by the manufacturer in accordance with a control plan.

b) tasks for the approved body:

- (3) initial type-testing of the product;
- (4) initial inspection of factory and of factory production control;
- (5) continuous surveillance, assessment and approval of factory production control.

### **3.2 Responsibilities**

#### **3.2.1 Tasks of the manufacturer; factory production control**

The manufacturer has established a factory production control system in the plant and exercises permanent internal control of production. All the elements, requirements and provisions adopted by the manufacturer are documented in a systematic manner in the form of written policies and procedures. The production control system ensures that the product is in conformity with the European Technical Approval.

The manufacturer shall only use raw materials supplied with the relevant inspection documents as laid down in the control plan<sup>8</sup>. The incoming raw materials shall be subject to controls and tests by the manufacturer before acceptance. Check of incoming materials such as anchor rods, nuts and washers, shall include control of the inspection documents presented by suppliers (comparison with nominal values) by verifying dimensions and determining material properties, e.g. tensile strength, hardness, surface finish.

---

<sup>8</sup> The control plan is deposited at the Deutsches Institut für Bautechnik and is handed over only to the approved bodies involved in the conformity attestation procedure.

The manufactured components of the anchor shall be subjected to the following tests:

- Dimensions of component parts:
  - anchor rod (diameter, length, thread);
  - hexagon nut (well running, wrench size across flats);
  - washer (diameter, thickness);
  - resin (fill quantity, fill weight);
  - hardener (fill quantity, fill weight).
- Material properties:
  - anchor rod (tensile strength, yield limit);
  - hexagon nut (proof load);
  - washer (hardness);
  - mortar (condition, curing time, viscosity);
  - hardener (condition, reactivity).
- Thickness of the zinc coating.
- Visual control of completeness of the anchor.

The frequency of controls and tests conducted during production is laid down in the control plan taking account of the automated manufacturing process of the anchor.

The results of factory production control are recorded and evaluated. The records include at least the following information:

- Designation of the product, raw material and components,
- Type of control or testing,
- Date of manufacture of the product and date of testing of the product or basic material and components,
- Result of control and testing and, if appropriate, comparison with requirements,
- Signature of person responsible for factory production control.

The records shall be presented to the inspection body involved in the continuous surveillance. On request they shall be presented to the Deutsches Institut für Bautechnik.

Details of the extent, nature and frequency of testing and controls to be performed within the factory production control shall correspond to the control plan which is part of the technical documentation of this European Technical Approval.

### 3.2.2 Tasks of approved bodies

#### 3.2.2.1 Initial type-testing of the product

For initial type-testing the results of the tests performed as part of the assessment for the European Technical Approval shall be used unless there are changes in the production line or plant. In such cases the necessary initial type-testing has to be agreed between the Deutsches Institut für Bautechnik and the approved bodies involved.

#### 3.2.2.2 Initial inspection of factory and of factory production control

The approved body shall ascertain that, in accordance with the control plan, the factory, in particular the staff and equipment, and the factory production control are suitable to ensure a continuous and orderly manufacturing of the anchor with the specifications mentioned in 2.1 as well as in the Annexes to the European Technical Approval.

#### 3.2.2.3 Continuous surveillance

The approved body shall visit the factory at least once a year for surveillance. It has to be verified that the system of factory production control and the specified automated manufacturing process are maintained taking account of the control plan.

Continuous surveillance and assessment of factory production control have to be performed according to the control plan.

The results of product certification and continuous surveillance shall be made available on demand by the certification body or inspection body, respectively, to the Deutsches Institut für Bautechnik.

In cases where the provisions of the European Technical Approval and the control plan are no longer fulfilled the conformity certificate shall be withdrawn.

### 3.3 CE marking

The CE marking shall be affixed on each packaging of anchors. The symbol "CE" shall be followed by the identification number of the certification body and shall be accompanied by the additional information:

- name or identifying mark of producer and manufacturing plant,
- the last two digits of the year in which the CE marking was affixed,
- number of the EC certificate of conformity,
- number of the European Technical Approval,
- use category (ETAG 001-1 Option 7),
- anchor size.

## 4 Assumptions under which the fitness of the product for the intended use was favourably assessed

### 4.1 Manufacturing

The anchor is manufactured in accordance with the provisions of the European Technical Approval using the automated manufacturing process as identified in the inspection of the plant by the Deutsches Institut für Bautechnik and the approved body and laid down in the technical documentation.

### 4.2 Installation

#### 4.2.1 Design of anchorages

The fitness of the anchor for the intended use is given under the following conditions:

The anchorages are designed in accordance with the "Guideline for European Technical Approval of Metal Anchors for Use in Concrete", Annex C, Method A, for bonded anchors under the responsibility of an engineer experienced in anchorages and concrete work.

For the verifications given below according to Annex C the following shall be observed:

- For the verification 'concrete cone failure' (clause 5.2.2.4, Annex C of the Guideline)  $N_{Rk,c}$  shall be determined according to (1) and (2): The smaller value of (1) or (2) is decisive.

(1)  $N_{Rk,c}$  according to equation (5.2), Annex C of the Guideline

where:  $N_{Rk,c}^0$  according to Table 5, Annex 6

$s_{cr,N}$  according to Table 5, Annex 6

$c_{cr,N}$  according to Table 5, Annex 6

$\psi_{ucr,N} = 1.0$

In the special cases given in ETAG 001 Annex C, 5.2.2.4g) the value  $N_{Rk,c}^0$  according to Table 5, Annex 6 shall be reduced:

$$N_{Rk,c}^0 = N_{Rk,c}^0 (\text{Table 5}) \times \frac{h'_{ef}}{h_{ef}}$$

(2)  $N_{Rk,c}$  according to equation (5.2), Annex C of the Guideline

$$\text{where: } N_{Rk,c}^0 = 0.75 \times 15.5 \times h_{ef}^{1.5} \times f_{ck,cube}^{0.5}$$

$$s_{cr,N} = 3 h_{ef}$$

$$c_{cr,N} = 1.5 h_{ef}$$

$$\psi_{ucr,N} = 1.0$$

- For the verification 'splitting failure due to loading' (clause 5.2.2.6, Annex C of the Guideline)  $N_{Rk,sp}$  shall be determined according to (3).

(3)  $N_{Rk,sp}$  according to equation (5.3), Annex C of the Guideline

$$\text{where: } N_{Rk,c}^0 \text{ according to Table 5, Annex 6}$$

$$s_{cr,sp} \text{ according to Table 5, Annex 6}$$

$$c_{cr,sp} \text{ according to Table 5, Annex 6}$$

$$\psi_{ucr,N} = 1.0$$

$$\psi_{h,sp} = 1.0$$

- For the verification 'concrete pryout failure' (clause 5.2.3.3, Annex C of the Guideline)  $N_{Rk,c}$  for equation (5.6), Annex C of the Guideline, shall be determined according to (1).

Verifiable calculation notes and drawings are prepared taking account of the loads to be anchored.

The position of the anchor is indicated on the design drawings (e.g. position of the anchor relative to reinforcement or to supports, etc.).

#### 4.2.2 Installation of anchors

The fitness for use of the anchor can only be assumed if the anchor is installed as follows:

- Anchor installation carried out by appropriately qualified personnel and under the supervision of the person responsible for technical matters of the site,
- Use of the anchor only as supplied by the manufacturer without exchanging the components of an anchor,
- Anchor installation in accordance with the manufacturer's specifications and drawings using the tools indicated in the technical documentation of this European Technical Approval,
- Checks before placing the anchor to ensure that the strength class of the concrete in which the anchor is to be placed is in the range given and is not lower than that of the concrete to which the characteristic loads apply,
- Check of concrete being well compacted, e.g. without significant voids,
- Edge distance and spacing not less than the specified values,
- Positioning of the drill holes without damaging the reinforcement,
- In case of aborted hole: The hole shall be filled with mortar,
- Cleaning of the drill hole by at least 4x blowing / 4x brushing / 4x blowing following the manufacturers installation instructions,
- The anchor must not be installed in flooded holes,

- anchor installation such that the effective anchorage depth is complied with. This compliance is ensured when the embedment mark of the anchor does no more exceed the concrete surface,
- Mortar injection by using the equipment including the static mixer shown in Annex 1; discarding the first swings of mortar (the specific number is given in the manufacturer's installation instruction) of each new cartridge, the injection mortar is sufficiently mixed when the colour has turned into a uniform grey; taking from the manufacturer's installation instruction the admissible processing time (open time) of a cartridge including pressing-in of the anchor rod as a function of the anchor component installation temperature and the ambient temperature of the concrete; filling the drill hole uniformly starting from the drill hole bottom, in order to avoid entrapment of air; removing the mixer slowly bit by bit during pressing-out; filling the drill hole with the minimum quantity of the injection mortar given in the manufacturer's installation instruction (appr. 2/3 of the drill hole; pressing the anchor rod by manual turning into the mortar-filled drill hole up to the marked anchorage depth; achieving the anchorage depth (installation depth), injection mortar must be visible at the member surface; replacing the static mixer if work is interrupted for a time exceeding the indicated processing time of the cartridge; the anchor component installation temperature shall be at least +5 °C; during curing of the injection mortar the temperature of the concrete must not fall below -5 °C; observing the curing time according to Annex 3, Table 3 until the anchor may be loaded; after the curing time fixing the fixture to be anchored by using a calibrated torque wrench by not exceeding the torque moment given in Annex 5, Table 4.

#### 4.2.3 Responsibility of the manufacturer

The manufacturer is responsible to ensure that the information on the specific conditions according to 1 and 2 including Annexes referred to and 4.2.1 and 4.2.2 as well as 5 is given to those who are concerned. This information may be made by reproduction of the respective parts of the European Technical Approval. In addition all installation data shall be shown clearly on the package and/or on an enclosed instruction sheet, preferably using illustration(s).

The minimum data required are:

- Diameter of drill bit,
- Hole depth,
- Diameter of anchor rod,
- Minimum effective anchorage depth,
- Maximum thickness of the fixture,
- Information on the installation procedure, including cleaning of the hole with the cleaning equipments, preferably by means of an illustration,
- Anchor component installation temperature,
- Ambient temperature of the concrete during installation of the anchor,
- Admissible processing time (open time) of a cartridge,
- Curing time until the anchor may be loaded as a function of the ambient temperature in the concrete during installation,
- Torque moment,
- Identification of the manufacturing batch.

All data shall be presented in a clear and explicit form.

## 5 Recommendations concerning packaging, transport and storage

The injection cartridges shall be protected against sun radiation and shall be stored according to the manufacturer's installation instructions in dry condition at temperatures of at least +5 °C to not more than +25 °C.

Mortar cartridges with expired shelf life must no longer be used.

The anchor shall only be packaged and supplied as a complete unit. Mortar cartridges may be packed separately from anchor rods, nuts and washers.

The manufacturer's installation instruction shall indicate that the Injection Mortar Pattex CF 900 shall be used with the anchor rods according to Annex 2.

Dipl.-Ing. E. Jasch

*Beglaubigt:*

Lange

Sealing cap



**Cartridge: Injection Mortar Pattex CF 900**

Imprint:  
 Pattex CF 900, processing notes, charge-code, storage-life, hazard-code, curing- and processing time (depending on the temperature), with as well as without travel scale

Static mixer

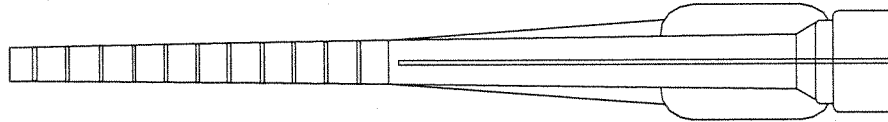

Anchor rod with washer and hexagon nut

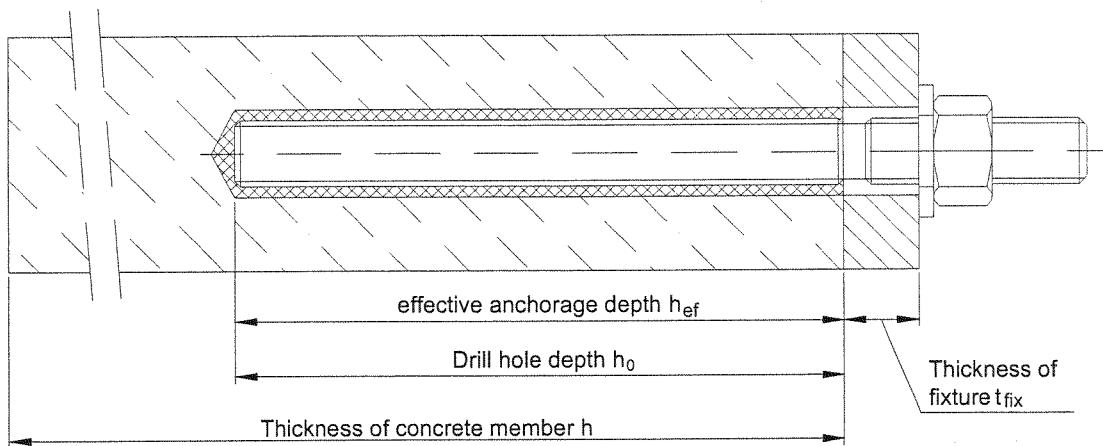
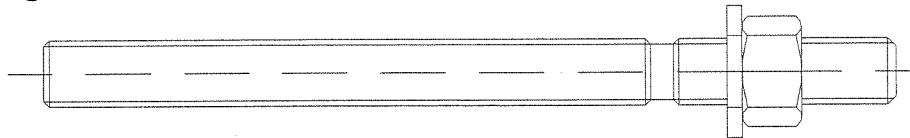

- Use category 1:
- Installation in dry or wet concrete
  - Service in dry internal conditions
  - No overhead installation

- Temperature range:
- 40°C to +80°C (max. short term temperature +80°C and max. long term temperature +50°C)
  - 40°C to +120°C (max. short term temperature +120°C and max. long term temperature +72°C)

Pattex CF 900 with Anchor Rod 5.8

Product and intended use

**Annex 1**  
 of European  
 Technical Approval  
**ETA-05/0133**

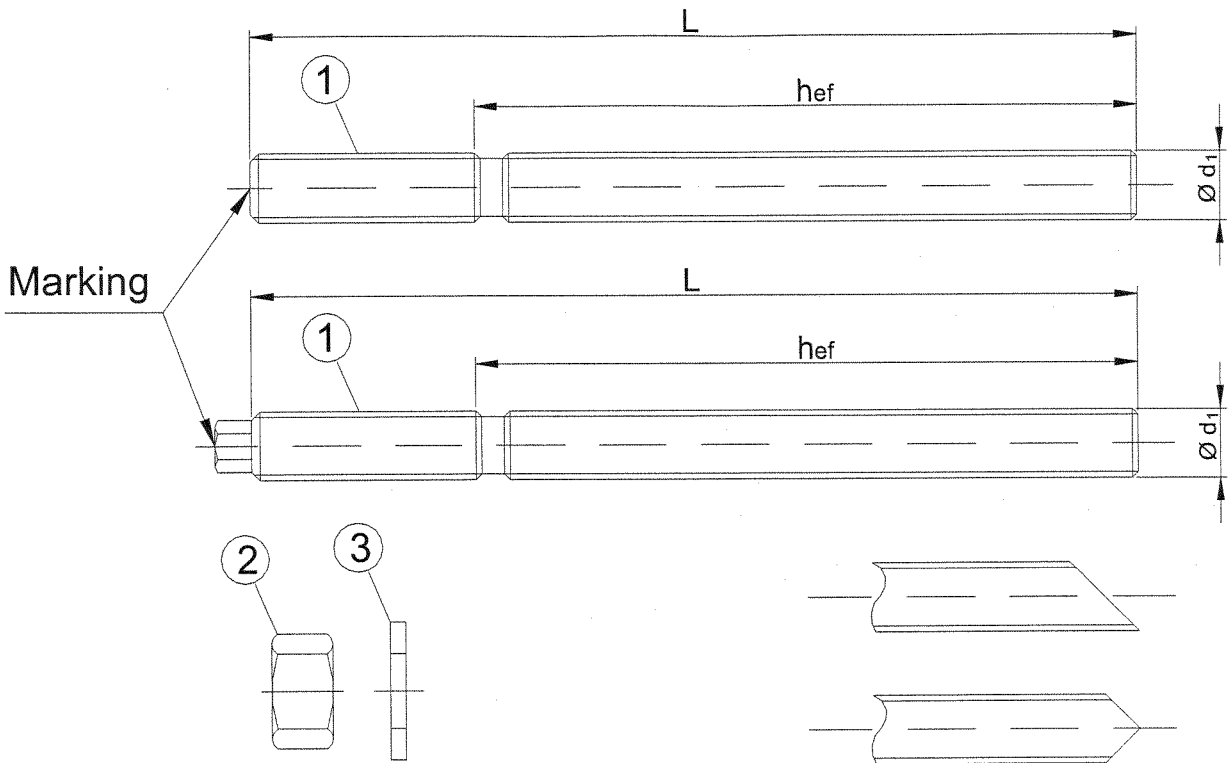

**Marking:**

Works symbol, anchor identity, anchor size,  
e.g.: CVM M12

Designation of anchor parts is given in Annex 3 (Table 2).

**Table 1: Anchor dimensions**

Size	Anchor rod		
	$\varnothing d_1$ [mm]	$h_{ef}$ [mm]	min $L$ <sup>1)</sup> [mm]
M 10	10	90	$\geq 110$
M 12	12	110	$\geq 130$
M 16	16	125	$\geq 145$

<sup>1)</sup> max  $L = 1500$  mm

Pattex CF 900 with Anchor Rod 5.8	<b>Annex 2</b> of European Technical Approval  <b>ETA-05/0133</b>
Anchor dimensions	

**Table 2: Materials**

Part	Designation	Steel, zinc plated $\geq 5 \mu\text{m}$
1	Anchor rod	Steel, property class 5.8 EN ISO 898-1, acc. to EN ISO 4042
2	Hexagon nut according to DIN 934	Property class 5 EN 20898-2, acc. to EN ISO 4042
3	Washer	Steel, acc. to EN ISO 4042
4	Chemical mortar	Bonding agent: vinylester-resin, styrene-free Additive: quartz sand Hardener: dibenzoyl peroxide

**Table 3: Minimum curing time**

Concrete temperature	Minimum curing time in dry concrete	Minimum curing time in wet concrete
$\geq -5 \text{ }^\circ\text{C}$	6 h	12 h
$\geq 0 \text{ }^\circ\text{C}$	3 h	6 h
$\geq +5 \text{ }^\circ\text{C}$	2 h	4 h
$\geq +10 \text{ }^\circ\text{C}$	80 min	160 min
$\geq +20 \text{ }^\circ\text{C}$	45 min	90 min
$\geq +30 \text{ }^\circ\text{C}$	25 min	50 min
$\geq +35 \text{ }^\circ\text{C}$	20 min	40 min

Pattex CF 900 with Anchor Rod 5.8

Materials,  
Curing times depending on the temperature
**Annex 3**  
of European  
Technical Approval  
  
**ETA-05/0133**

**150 ml, 280 ml, 300 ml, 330 ml, 380 ml and 410 ml injection mortar cartridge (type: coaxial)**

Sealing/Screw cap

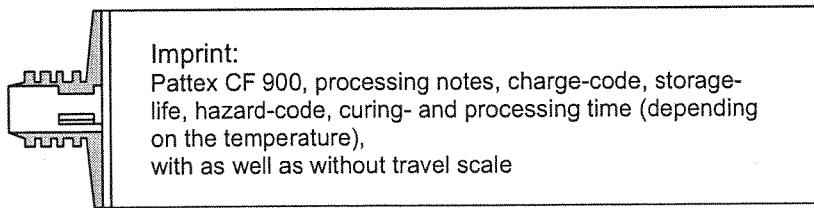
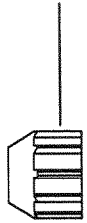

Imprint:  
Pattex CF 900, processing notes, charge-code, storage-life, hazard-code, curing- and processing time (depending on the temperature), with as well as without travel scale

Component B: Hardener (inner tube)

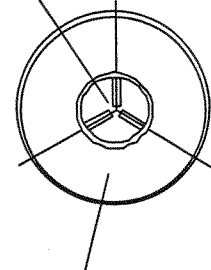

Component A: Injection mortar (outer tube)

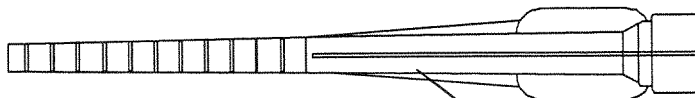

Static Mixer, one-way tool, must be changed in case of working interruption

**345 ml injection mortar cartridge (type: side-by-side)**

Sealing/Screw cap

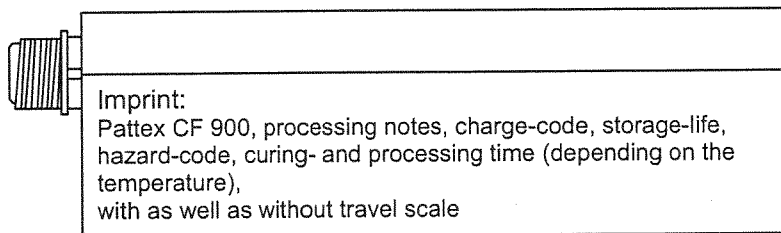
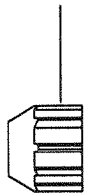

Imprint:  
Pattex CF 900, processing notes, charge-code, storage-life, hazard-code, curing- and processing time (depending on the temperature), with as well as without travel scale

Component B: Hardener

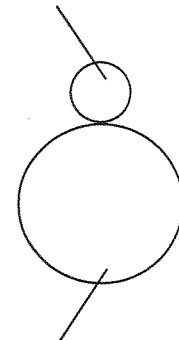

Component A: Injection mortar

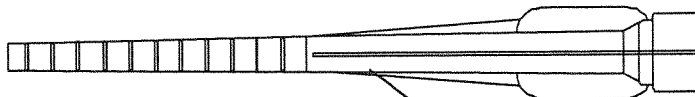

Static Mixer, one-way tool, must be changed in case of working interruption

Pattex CF 900 with Anchor Rod 5.8

Mortar cartridges

**Annex 4**  
of European  
Technical Approval  
**ETA-05/0133**

**Table 4: Installation parameters**

Anchor size		M 10	M 12	M 16
Nominal drill hole diameter	$d_0$ [mm] =	12	14	18
Cutting diameter of drill bit	$d_{cut}$ [mm] ≤	12.5	14.5	18.5
Depth of drill hole	$h_0$ [mm] ≥	90	110	125
Diameter of clearance hole in the fixture	$d_f$ [mm] ≤	12	14	18
Diameter of steel brush	$d_b$ [mm] ≥	14	16	20
Torque moment	$T_{inst}$ [Nm]	20	40	60
Thickness of fixture	$\min t_{fix}$ [mm] >	0		
	$\max t_{fix}$ [mm] <	1400	1380	1360
Minimum thickness of member	$h_{min}$ [mm]	130	160	160
Minimum spacing	$s_{min}$ [mm]	90	110	125
Minimum edge distance	$c_{min}$ [mm]	45	55	62.5

**Steel brush**

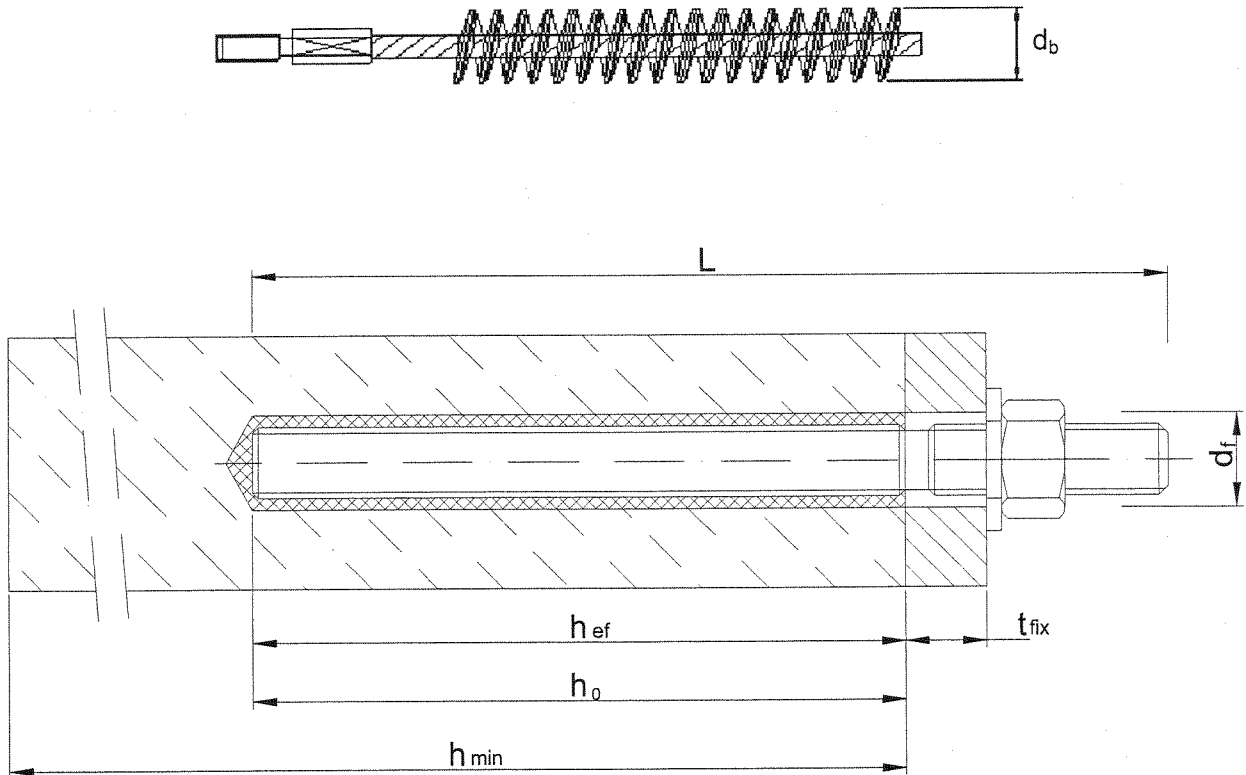

Pattex CF 900 with Anchor Rod 5.8

Installation parameters

**Annex 5**  
of European  
Technical Approval  
**ETA-05/0133**

**Table 5: Design method A:  
Characteristic values for tension loads**

Anchor size		M 10	M 12	M 16
<b>Steel failure</b>				
Characteristic resistance	$N_{Rk,s}$ [kN]	30	44	82
Partial safety factor	$\gamma_{Ms}$ <sup>1)</sup>	1.56		
<b>Pullout and Concrete cone failure</b>				
Non-cracked concrete C20/25 (50 °C / 80 °C) <sup>3)</sup>	$N_{Rk,c}^0 = N_{Rk,p}$ [kN]	20	25	35
Non-cracked concrete C20/25 (72 °C / 120 °C) <sup>3)</sup>	$N_{Rk,c}^0 = N_{Rk,p}$ [kN]	16	20	30
Increasing factors for non-cracked concrete $\Psi_c$	C30/37	1.22		
	C40/50	1.41		
	C50/60	1.55		
Effective anchorage depth	$h_{ef}$ [mm]	90	110	125
Characteristic edge distance	$c_{cr,N}$	90	110	125
Characteristic spacing	$s_{cr,N}$	180	220	250
Partial safety factor	$\gamma_{Mc} = \gamma_{Mp}$ <sup>1)</sup>	1.8 <sup>2)</sup>		
<b>Splitting failure</b>				
Spacing	$s_{cr,sp}$ [mm]	180	220	250
Edge distance	$c_{cr,sp}$ [mm]	90	110	125
Partial safety factor	$\gamma_{Msp}$ <sup>1)</sup>	1.8 <sup>2)</sup>		

<sup>1)</sup> In absence of other national regulations

<sup>2)</sup> The partial safety factor  $\gamma_2 = 1.2$  is included.

<sup>3)</sup> Maximum long term temperature/ maximum short term temperature

**Table 6: Displacements for tension loads**

Anchor size		M 10	M 12	M 16
Tension load	N [kN]	6.6	8.3	11.6
Displacement	$\delta_{N0}$ [mm]	0.3	0.5	0.4
	$\delta_{N\infty}$ [mm]	0.6	1.6	2.0

Pattex CF 900 with Anchor Rod 5.8

Design Method A:  
Characteristic values for tension loads,  
Displacements

**Annex 6**

of European  
Technical Approval

**ETA-05/0133**

**Table 7: Design method A:  
Characteristic values for shear loads**

Anchor size		M 10	M 12	M 16
<b>Steel failure without lever arm</b>				
Characteristic resistance	$V_{Rk,s}$ [kN]	15	22	41
Partial safety factor	$\gamma_{Ms}^{1)}$	1.30		
<b>Steel failure with lever arm</b>				
Characteristic resistance	$M^0_{Rk,s}$ [Nm]	39	68	173
Partial safety factor	$\gamma_{Ms}^{1)}$	1.30		
<b>Concrete pryout failure</b>				
Factor k in equation (5.6) of ETAG 001, Annex C, Section 5.2.3.3		2.0		
Partial safety factor	$\gamma_{Mc}^{1)}$	1.50 <sup>2)</sup>		
<b>Concrete edge failure</b>				
Effective length of anchor in shear loading	$\ell_f$ [mm]	90	110	125
Outside diameter of anchor	$d_{nom}$ [mm]	12	14	18
Partial safety factor	$\gamma_{Mc}^{1)}$	1.50 <sup>2)</sup>		

<sup>1)</sup> If no other national regulations exist

<sup>2)</sup> The partial safety factor  $\gamma_2 = 1.0$  is included.

**Table 8: Displacements for shear loads**

Anchor size		M 10	M 12	M 16
Shear load	$V$ [kN]	6.6	8.3	11.6
Displacement	$\delta_{V0}$ [mm]	0.4	1.1	1.3
	$\delta_{V\infty}$ [mm]	0.6	1.6	2.0

Pattex CF 900 with Anchor Rod 5.8

Design Method A:  
Characteristic values for shear loads,  
Displacements

**Annex 7**  
of European  
Technical Approval

**ETA-05/0133**